



INSTALLATION INSTRUCTIONS

TurboJet™ Power System
 from the makers of *Evinrude®* and *Johnson®* Outboards
3-Cylinder and Cross-Flow V4

SAFETY

These instructions contain information that can help prevent personal injury and damage to equipment. Understand the following symbols before proceeding:

 Safety Related	Alerts you to the possibility of danger and identifies information that will help prevent injuries.
Note	Identifies information that will help prevent damage to machinery.
Important	Appears next to information that controls correct assembly and operation of the product.

TO THE INSTALLER

Place these instructions in the owner's packet for future reference.

Note It's the responsibility of the installer to position and install the power system properly. An installation that permits water to enter the engine will void its warranty.

PREFACE

These instructions provide the installer with the information necessary to install the *TurboJet™* power system.

Anyone using installation procedures or tools not recommended must first be satisfied that neither their own nor the user's safety will be jeopardized by the installation methods selected.

To the Boat Builder

The *TurboJet™* power system meets or exceeds all applicable U.S. Federal Regulations covering recreational boats as required under Title 46 of the United States Code enacted by Public Law 98-89, August 26, 1983.

The requirements under this Code encompass all recreational boats to be sold in the 50 states of the United States, Guam, Puerto Rico, the Virgin Islands, American Samoa, the District of Columbia, the Northern Mariana Islands, and any other territories or possessions of the United States.

Three technical booklets of special importance to help boat manufacturers understand and comply with these U.S. federal regulations are:

- Electrical System Compliance Guideline
AD/A-049-638
- Fuel System Compliance Guideline
AD/A-047-767
- Ventilation System Compliance Guideline
AD/A-114-507

These and other technical booklets are available from:

National Technical Information Service (NTIS)
U.S. Department of Commerce
Springfield, Virginia 22161 Phone (703) 487-4650

To order any of the above technical booklets, telephone NTIS for the quotation coding which must be added to the publication order number and for the cost of the publications to be included in your order.

 The *TurboJet* power system must be coupled to a mechanical push-pull steering system. The boat's steering system is important for control of the boat. It is also critical to the safety of persons in the boat or in its general area. We recommend the installer follow the **American Boat and Yacht Council's Safety Standard P-17 for all aspects of the steering system to ensure that each steering system component meets the minimum requirements.**

A copy of the current ABYC Standard P-17 is available from:

American Boat and Yacht Council
3069 Solomon's Island Road
Edgewater MD USA 21037 Phone (410) 956-1050

Install the helm, steering wheel, and steering cable following the steering system manufacturer's instructions and specifications.

Install the remote control assembly and remote control cables following manufacturer's instructions and specifications.



Installation Procedures

 Proper installation is important for the safe, reliable operation of all mechanical products. The procedures we recommend and describe in these instructions are effective methods. Some of these methods require the use of specially designed tools which should be used when and as recommended.

We may warn against the use of specific installation or operation methods that can damage the product or render it unsafe. However, these warnings are not all-inclusive. We cannot possibly know of and evaluate all possible ways of installation or operation and warn of possible hazardous consequences of each way. You must use common sense, caution, and care during installation and operation of this product.

The following sequential steps permit complete installation of the *TurboJet™* power system:

Installation Procedure Steps	Page
Prepare for Installation.	4
General Information.	5
Prepare the Hull.	6
Uncrate Engine and Jet Assembly.	7
Install Steering Cable.	8
Install Shift Cable.	9
Install Throttle Cable.	10
Install Battery.	11
Install Engine and Jet Assembly.	12
Install Front Plate and Intake Grille.	13
Final Connections.	13
New Product Pre-Delivery Checks.	14
Test Procedures.	15



Prepare for Installation

Read installation instructions completely before starting work.

Additional Equipment Required:

- Steering wheel, helm, and cable
- Throttle and shift cables
- Instrument harness
- Emergency stop switch
- Warning horn
- Battery and cables
- Oil Tank
- Fuel system
- Remote control with the following features:
 - 1) SINGLE-LEVER ONLY
 - 2) Start-in-Gear Prevention

OMC Service Tools:

- *OMC* Drilling Fixture, P/N 340719
- *OMC* Lifting Eye and Adapter Assembly, P/N 396748. Use the 1 $\frac{1}{8}$ in. screws.

Hand Tools:

- Wrenches and sockets – $\frac{1}{4}$ in. to 1 in.
- Hex wrenches – 6 mm and 8 mm
- Electric drill with $\frac{1}{2}$ in. chuck
- Drill bits – $\frac{1}{4}$ in., $\frac{5}{16}$ in.
- Torque wrench
- Screwdrivers
- Drift punch
- Hammer
- Pliers set

Sealants and Lubricants:

- *OMC Triple-Guard®* Grease
- *OMC Gasket Sealing Compound*
- High quality gasoline and oil resistant marine sealant

General Information

The *TurboJet™* power system uses 2-cycle engine technology.

Powerhead size and assembly weight:

70 – Height	29 ³ / ₈ in. (75 cm)
Width	23 ¹ / ₂ in. (60 cm)
Length (including muffler)	21 ³ / ₁₆ in. (54 cm)
Engine and Pump Weight	190 lbs. (90 kg)
90 and 115 – Height	27 ¹ / ₈ in. (69 cm)
Width	28 ³ / ₈ in. (73 cm)
Length (including muffler)	24 ¹ / ₂ in. (63 cm)
90 – Engine and Pump Weight	246 lbs. (112 kg)
115 – Engine and Pump Weight	250 lbs. (113 kg)

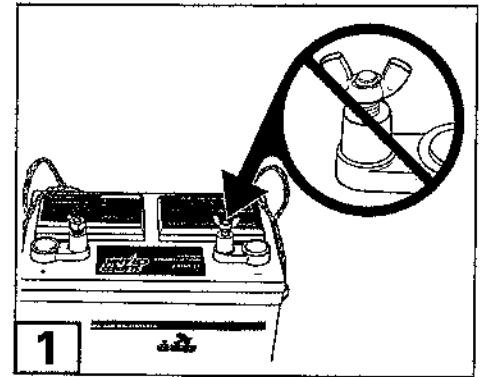

Engine Air Intake Requirements

Use the following formula to calculate the volume of air (cubic feet per minute) required for the engine – assuming the engine has 100% volumetric efficiency:

$$\text{CFM} = \frac{\text{Engine CID} \times \text{RPM}}{1728}$$

Fuel System

⚠ U.S. Coast Guard regulations require that an antisiphon valve be installed in fuel systems having any portion of the fuel supply line below the top of the fuel tank.

Note An antisiphon valve of adequate size must be used to ensure adequate fuel flow.

Fuel distribution hoses in the boat must deliver fuel at the rate of flow needed by the engine. Inside diameter of fuel hoses and connected components must be at least ³/₈ in. (9 mm)

Battery Requirements

Required is at least one heavy-duty, marine 12-volt battery that can be either maintenance-free, vented/refillable, or deep-cycle. If deep-cycle, it must carry a CCA or an MCA rating.

Minimum cranking power requirements – 360 CCA (465 MCA) with 90 minutes of reserve capacity (50 ampere-hours).

1 Note Use bolts and nuts to secure battery cables to the battery. DO NOT use wing nuts, even if they were supplied with the battery. Wing nuts will work loose. Loose battery cables can cause errant warning horn signals or damage to the electrical system.

⚠ Loose battery cables can also be a cause of explosion and fire if the battery is mounted in the enclosed engine compartment.



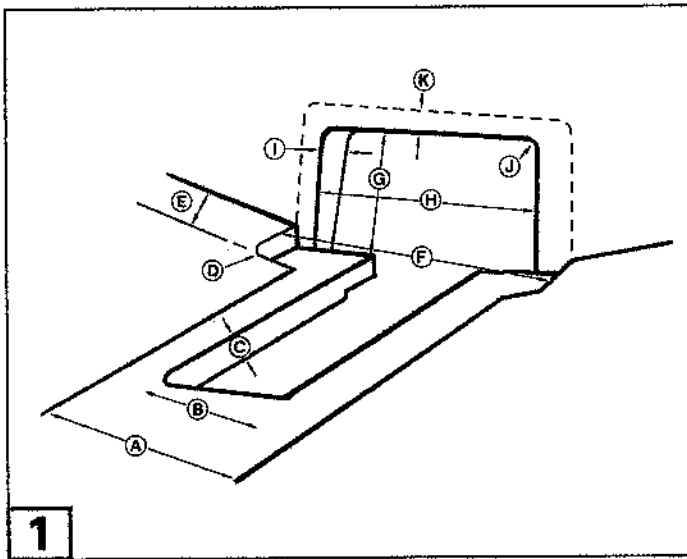

DR4970

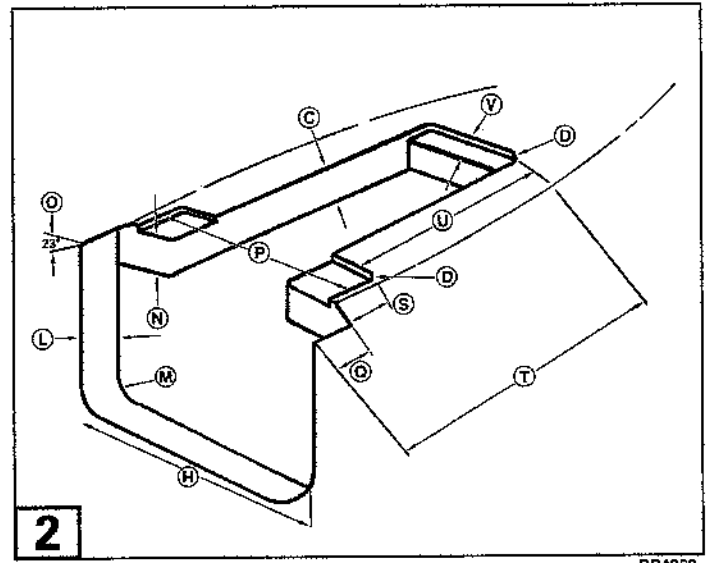

DR4969

Prepare the Hull

The aft section of the hull and transom must be specially prepared to receive the *TurboJet™* power system. **The first requirement is that the boat's transom angle MUST be 2°.**

1 Inside hull dimensions required:

- | | |
|------------------|------------------|
| (A) 9½ in. | (G) 11½ in. |
| (B) 7 in. | (H) 11 in. |
| (C) 1½ in. | (I) 1½ in. |
| (D) ½ in. radius | (J) 1 in. radius |
| (E) 2⅝ in. | (K) 1 in. |
| (F) 13⅛ in. | |

2 Outside hull dimensions required:

- | | |
|------------------|-------------|
| (D) ½ in. radius | (P) 8½ in. |
| (H) 11 in. | (Q) 1½ in. |
| (L) 1½ in. | (S) 2 in. |
| (M) 1 in. radius | (T) 24⅛ in. |
| (N) 1¼ in. | (U) 20⅝ in. |
| (O) 23° | (V) 1⅜ in. |

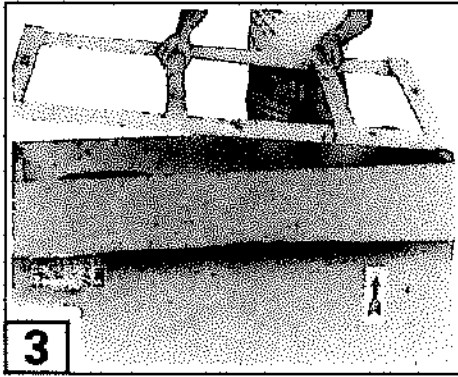

34273

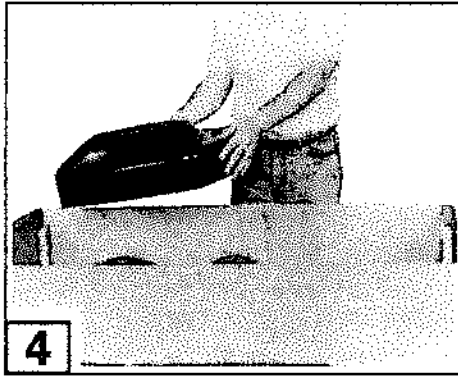

34271

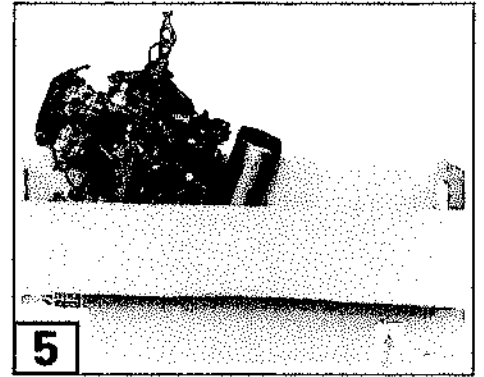

34294

Uncrate Engine and Jet Assembly

- 3** 1. After opening the box, remove the wood frame.
- 4** 2. Remove the flywheel cover from the powerhead and set it aside.
3. Install *OMC* lifting eye, P/N 396748, using the 1½ in. screws. Be sure the screws fully engage the flywheel.
- 5** 4. Connect a hoist of adequate capacity to the lifting eye. Refer to **General Information** for weights of engines. Lift assembly up and out of the box.
5. a) Place the engine assembly aside to await installation in the boat, or . . .
b) . . . leave the assembly hoisted in the air while you position it over its bed in the boat. Leave it **SUSPENDED** while you route and connect the steering cable. You may also route the shift and throttle cables at this time. The connection points are easier to access before the engine assembly has been lowered into final position.

⚠ While working with a suspended engine assembly, wedge blocks between the bottom of the engine and the boat under it. The blocks will steady the engine assembly during your work and prevent it from falling if the hoist should fail.



Install Steering Cable

1. Remove the aft washer and nut assembly from the steering cable.

1 2. Insert engine end of the steering cable through its hole in the starboard side of the transom plate.

3. Cover the mounting surfaces of the forward washer and nut with high quality marine sealer that is resistant to gasoline and oil.

4. Seat the forward washer against the transom plate and tighten the nut finger tight.

2 5. Cover the mounting surfaces of the aft washer and nut with high quality marine sealer that is resistant to gasoline and oil.

6. Slip the aft washer and nut over the cable end and up to the transom plate. Tighten the nut finger tight.

7. Center the rudder assembly on the jet housing nozzle.

3 8. Thread the jam nut **A** and cable adaptor **B** onto the steering cable, turning the adaptor at least nine revolutions.

9. Position the cable at midtravel by turning the steering wheel lock-to-lock, then returning it halfway.

⚠ 10. Turn the cable adaptor until its hole aligns with the threaded hole in the rudder. **However, the adaptor must maintain at least nine turns on the cable, or it could separate and result in loss of steering control.**

11. If additional steering cable adjustment is needed to align the holes in the cable adaptor and rudder, loosen the forward and aft steering cable nuts and push or pull the steering cable as needed.

4 12. When the steering cable is adjusted correctly, tighten the forward and aft nuts to 18 ft. lbs. (24 N·m) and wipe excess sealer from both nut assemblies.

3 13. Install the steering cable bushing **C** on the connector.

3 14. Apply *OMC Triple-Guard* grease to the shoulder screw **D** and install the screw in its threaded hole.

5 **⚠** 15. Install the cable and connector to the shoulder screw. Torque the screw to 60-80 in. lbs. (7-9 N·m). Thread locknut **E** onto the shoulder screw and tighten securely.

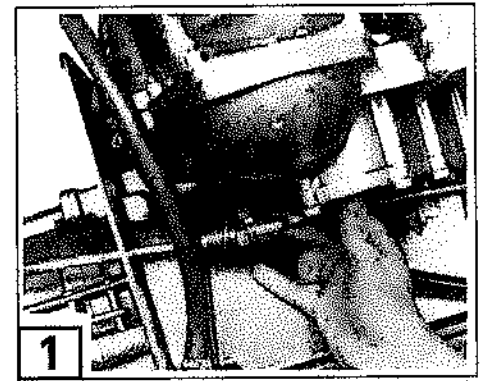

34291

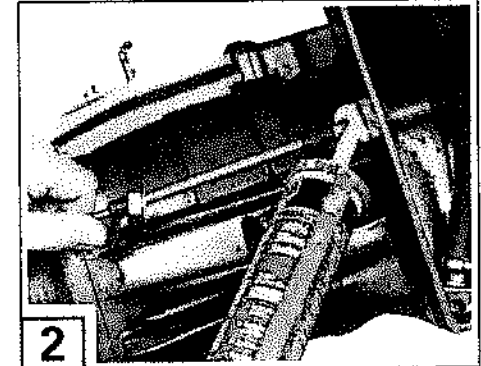

34296

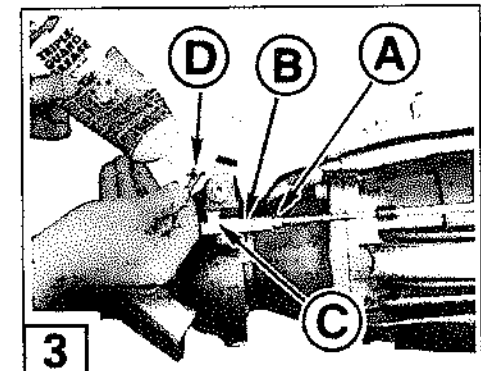

34270

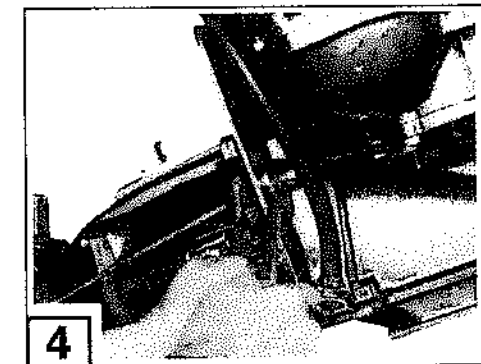

34288

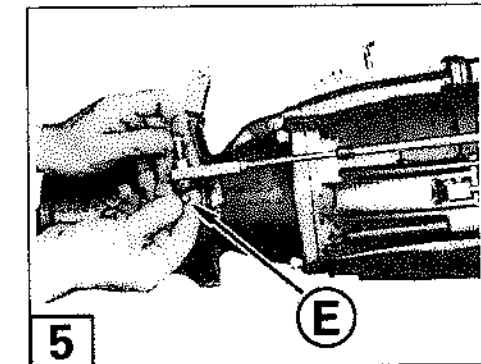

34289



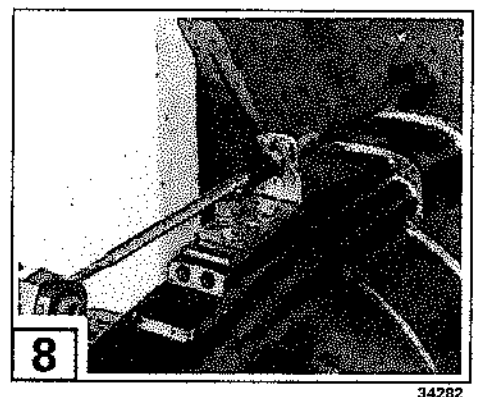
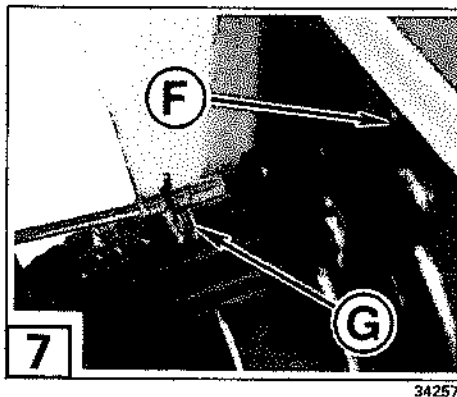
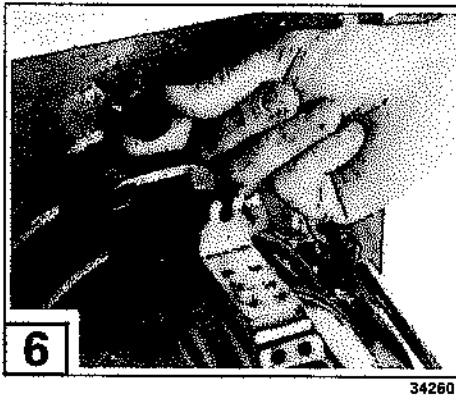

Install Shift Cable

- 6** 1. Remove the nut and O-ring assembly.
- 7** 2. Insert the engine end of the cable through its hole **F** in the top of the transom plate.
3. Slide the O-ring, then the nut, over the cable end.
4. Seat the O-ring in its pocket in the nut.
- 7** 5. Snap the cable into its retainer **G** on top of the gate to align the nut.
- 8** 6. Swivel the locking lever over the top of the cable and snap it down to lock the cable in the retainer.
7. Slide the nut and O-ring assembly onto the threaded flange on the transom plate. Tighten the nut to 60-80 in. lbs. (7-9 N·m).
- 9** 8. Slide the cable sleeve **H** over the cable joint.
- 9** 9. Install backing nut **I** on the cable.
- 9** 10. Install cable end **J** on the cable.
11. Adjust the cable and the gate for REVERSE by extending the cable fully and placing the gate all the way down.
- 10** 12. Install the cable end onto the retainer on top of the gate.
- 10** **11** 13. Insert the shoulder screw and tighten to 120-140 in. lbs. (14-16 N·m).
14. Tighten the backing nut against the cable end.

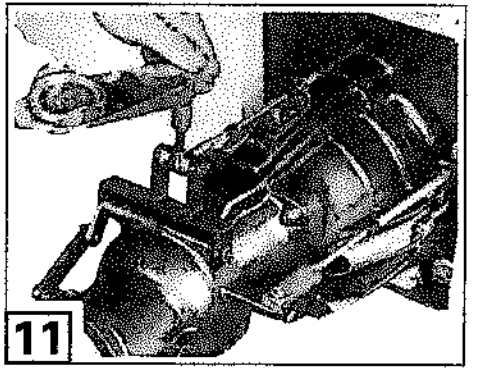
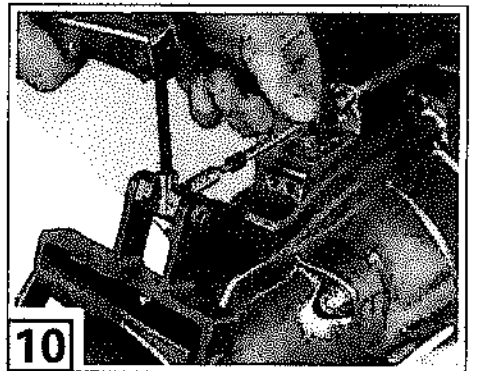
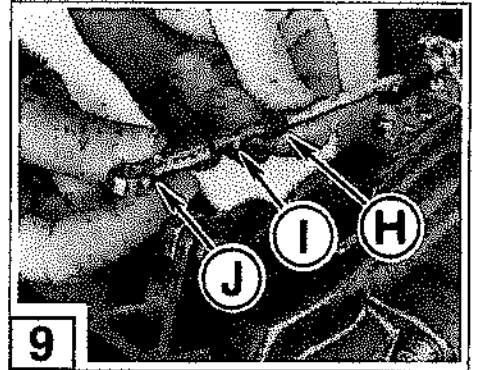

Install Throttle Cable

Remote Control End of Cable

⚠ Install the remote control end of the throttle cable in a single-lever remote control. **DO NOT** use a foot throttle or a dual-lever remote control.

1. a) **3-Cylinder** – Install the throttle cable in the remote control so it **PUSHES** to open the throttle on the engine.

b) **V4** – Install the throttle cable in the remote control so it **PULLS** to open the throttle on the engine.

Engine End of Cable

2. a) **3-Cylinder** – Route the engine end of the throttle cable aft along the starboard side of the boat and over to the front of the engine.

b) **V4** – Route the engine end of the throttle cable aft along the starboard side of the boat to the engine compartment. Route the cable in front of the engine to the port side and around the engine, coming forward to the starboard side of the engine.

1 3. Extend the cable and lubricate with *OMC Triple-Guard* grease.

4. Move the remote control handle to the **FORWARD** detent and then **halfway** back to **NEUTRAL**. This positions the control for accurate throttle cable adjustment.

5. Seat the engine throttle lever tightly against the idle stop screw.

2 **⚠** 6. Connect the cable casing guide to the throttle lever pin using the locknut and washer supplied with the engine. Tighten the locknut securely.

7. Pull the throttle cable firmly to remove backlash and install the trunnion nut in the anchor pocket.

3 8. Install the cable retainer and its washer and nut.

9. Final adjustment should be made when the engine is run for pre-delivery checks.

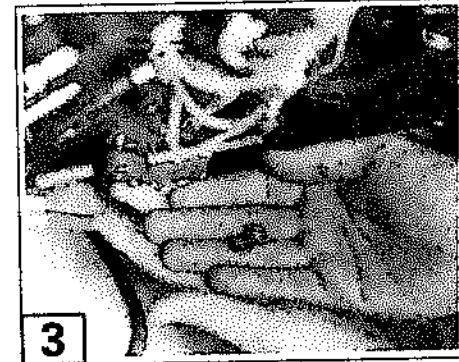
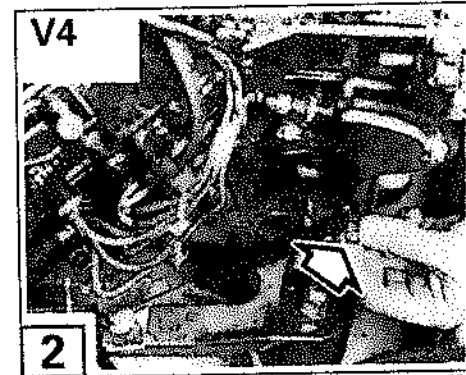
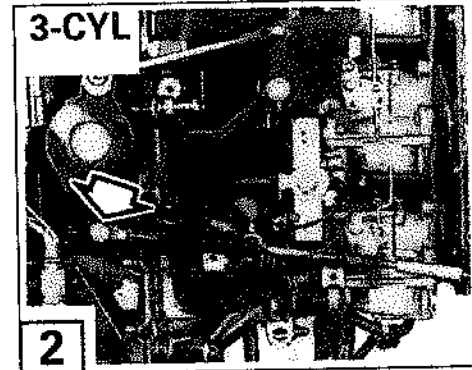
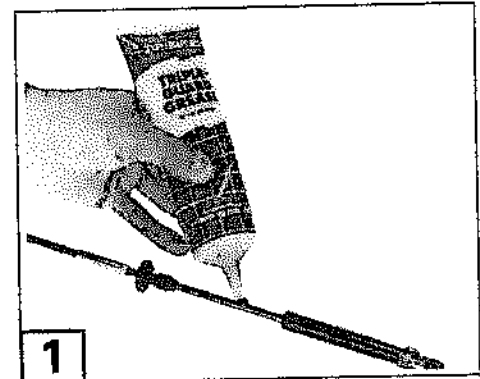

Install Battery

4 1. Position the battery in the stern of the boat near the engine, but where it is readily accessible. Secure it in a battery box or tray designed for marine use. A loose battery could be damaged, spill liquid contents, or loosen its cable connections.

Note Loose battery connections can cause errant warning horn signals and extensive damage to charging system components.

⚠ Loose battery cables can also be a cause of explosion and fire if the battery is mounted in the enclosed engine compartment.

5 2. Install *OMC* battery terminals, P/N 385407, or equivalent, on the battery posts to connect the cables. Installing cables with wing nuts on battery post studs will not provide a secure enough connection. **DO NOT** use wing nuts. Use standard nuts over the battery cable end or bolts and nuts on battery terminals.

⚠ If you mount the battery in a tray with its terminal posts exposed, install nonconductive boots over the connections to help prevent accidental shorting across posts.

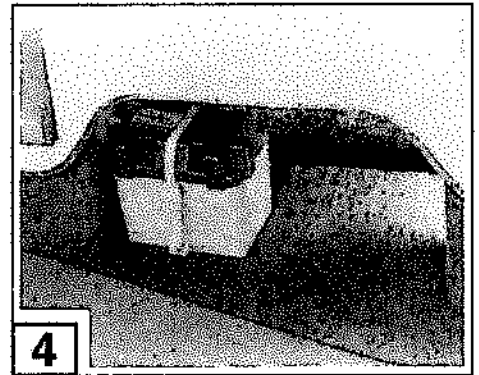

0064

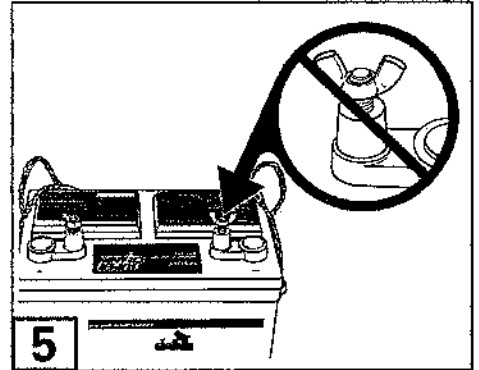

DR4925



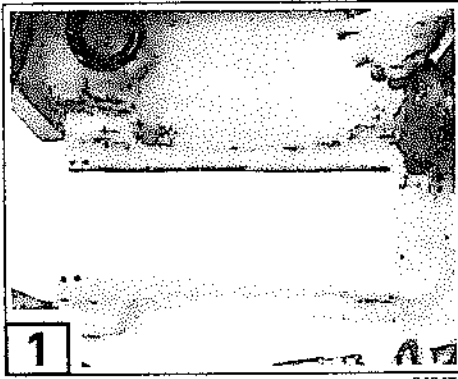

34247

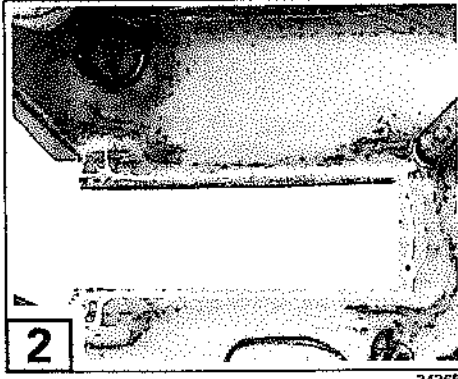

34268

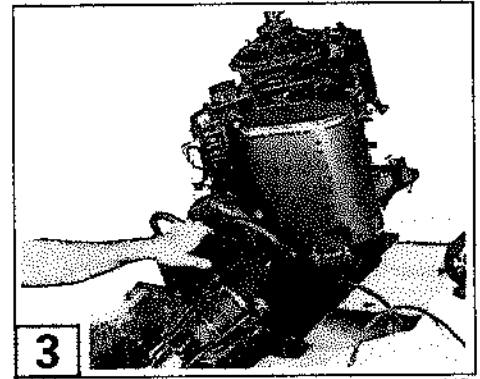

34267

Install Engine and Jet Assembly

1 1. Cover the jet unit mounting plate area with the drill fixture.

2. Drill six $\frac{5}{16}$ in. (8 mm) holes in the hull. Remove the drill fixture.

2 3. Apply a bead of high quality marine sealer that is gasoline and oil resistant to the flange of the cutout before seating the engine assembly. Apply the sealer all the way around on the inside edge of the hull and transom portions of the cutout.

3 4. Lower the engine assembly into position by slowly and simultaneously lowering the hoist and pushing the jet unit downward further with your hand to guide it down and through the transom portion of the cutout.

4 5. For final positioning, get under the boat and insert a drift punch into the mounting holes and then into each of the tapped holes in the base of the engine mounting plate. Move the engine slightly until all the holes align.

6. Drill two pilot holes through the boat's transom by using the engine's transom plate as a template. Point the drill aft and place the bit in the holes in the transom plate. Drill the holes from inside the engine compartment.

5 7. Increase the two pilot holes to $\frac{5}{16}$ in. (8 mm) by drilling now from outside the engine compartment.

8. Apply sealer to the two thru-transom bolts. Install and torque them to 120-140 in. lbs. (14-16 N·m).

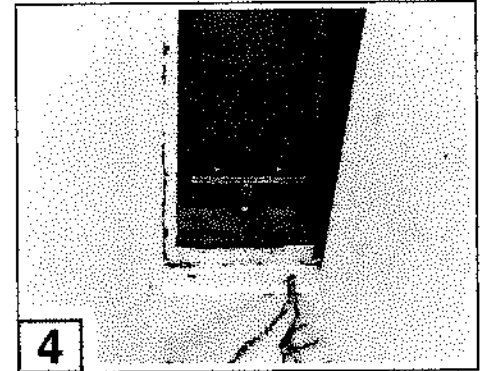

34265

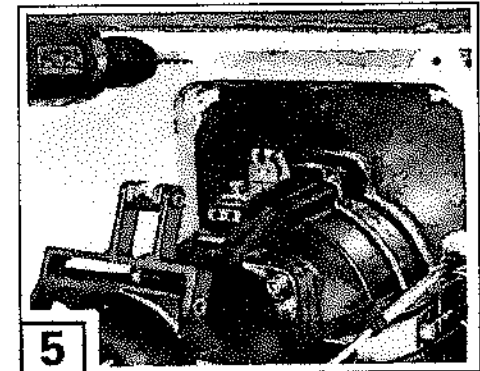

34261

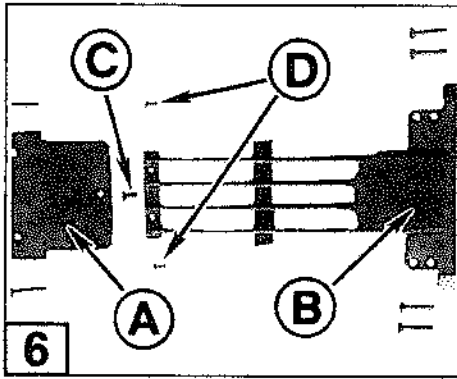

34292

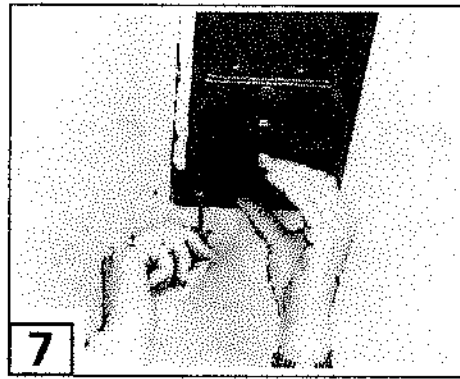

34264

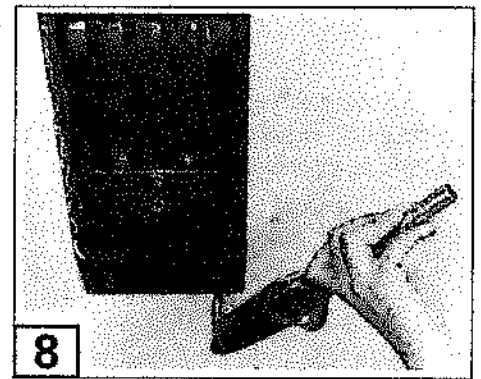

34263

Install Front Plate and Intake Grille

6 7 1. Install the front plate **A** from under the boat by holding the plate against the forward portion of the hull cutout.

7 2. Apply high quality marine sealer that is gasoline and oil resistant to two long 8 mm screws. Insert them into the holes in the plate's forward edge, through the drilled holes in the forward flange of the hull cutout, and into the tapped holes in the bottom of the jet unit mounting plate. Tighten with fingers.

6 8 3. Install the grille **B** aft of the front plate using four long 8 mm screws in the four aft holes. Tighten with fingers.

6 8 4. Secure the grille to the front plate with the short 8 mm screw **C** in the center hole and two 6 mm screws **D** in the slanted holes.

4. After all screws have been seated, torque:

- the two 6 mm screws **D** to 60-80 in. lbs. (7-9 N·m)
- the seven 8 mm screws to 120-140 in. lbs. (14-16 N·m)

5. Wipe excess sealer from all parts.

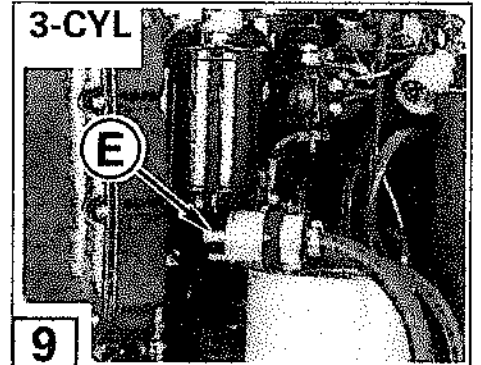

33905

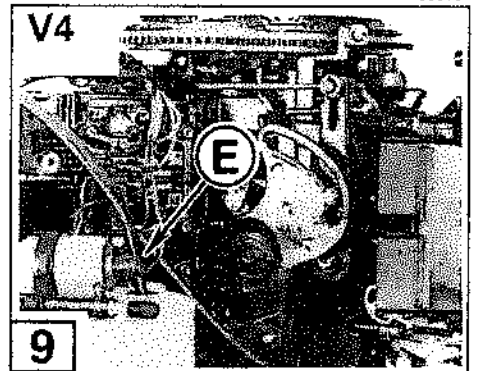

33897

Final Connections

9 **!** 1. Connect the fuel hose to its nipple **E** on the fuel filter and retain with a worm drive clamp. **Do not use a spring or wire clamp.**

10 2. Install the flywheel cover.

11 3. Connect the engine wiring harness – apply a small amount of *OMC Triple-Guard* grease to the plug on the instrument harness. Align its arrow with the arrow on the cable receptacle, and push the connectors firmly together. Secure the connection with the spring clip, and snap the clip into the retainer.

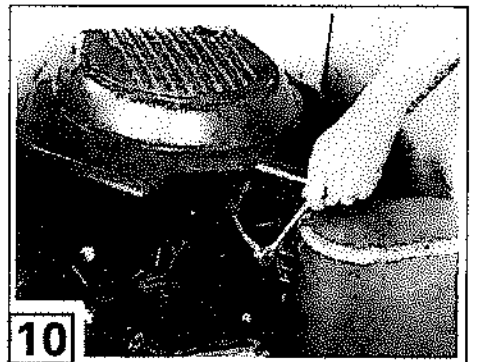

34272

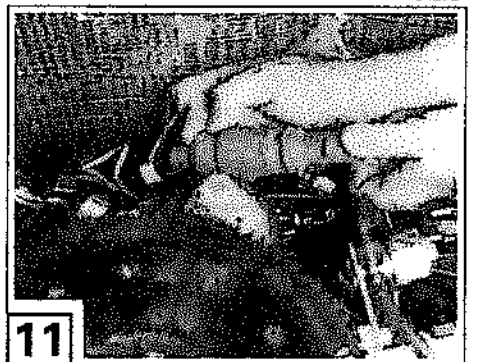

34230



New Product Pre-Delivery Checks

1. Check and tighten all clamps, paying special attention to fuel hose connections. Make sure all battery and electrical connections are complete and tight.

1 2. Check jet unit oil reservoir level. Oil should be up to the bottom of the threads on the filler. If low, top it off with *OMC Ultra-HPF™* gearcase lubricant.

Connect Oil Supply Hose and Prime Oil System

Important Prime the oil system BEFORE priming the fuel system. If the fuel system is primed first, the oil system must be primed with the engine idling.

Note Follow these steps before installing the oil supply hose on the engine. The oil hose and its connection must be air free and airtight. Air in the system will displace oil and reduce engine lubrication, causing engine damage.

1. Fill the oil tank with *Evinrude* or *Johnson TC-W3* outboard lubricant. Mark the oil level with tape so oil consumption during break-in can be visibly monitored.

2. Route the oil hose to the powerhead alongside the low oil warning wire and the oil tank ground wire.

2 3. Purge foreign material and ALL air from the hose by holding the oil primer bulb with its outlet end up and squeezing it until oil flows through the hose and into a waste container.

4. Remove the protective cap from the oil inlet fitting and store it on the yellow cap holder on the fuel hose.

3 4. Connect the oil tank hose to the oil inlet fitting (A) and secure with a clamp. Clean up any spilled oil.

5. Squeeze the oil primer bulb three more times to fill the system with oil.

6. Be sure the gasoline supply contains *TC-W3* outboard lubricant until oil system function has been verified.

Check Throttle Cable Adjustment

Check throttle cable adjustment with the engine running. If too loose, idle speed might be high and inconsistent – if too tight, the control handle might bind. Adjust by turning the trunnion nut in or out, as needed.

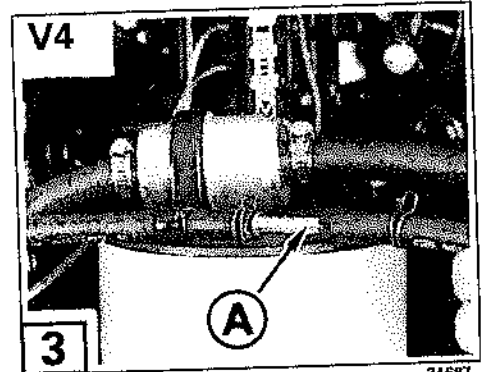
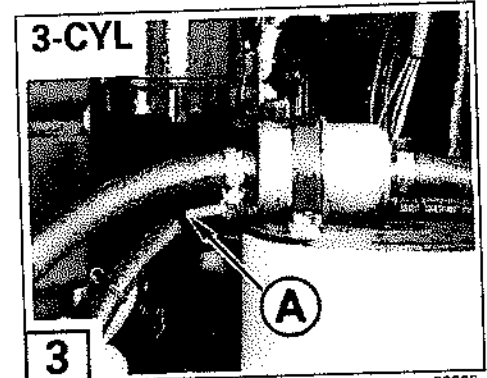
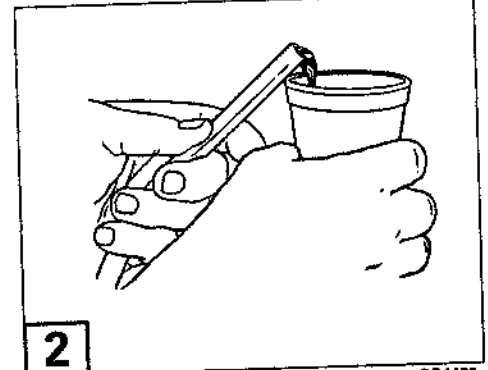

Test Procedures

Warning Horn

Note When the key switch is turned ON, the warning horn will beep once as a self-test. Check the wiring connections if it does not beep as described.

Start-in-Neutral-Only

4 **⚠** The recommended remote control is designed to allow starting in **NEUTRAL** only. If the control handle is in **FORWARD** or **REVERSE**, the engine must not crank.

1. Test by placing the control handle in **FORWARD** and turning the key switch to **START**. Move the control handle to **REVERSE** and turn the key switch to **START**. The engine must not crank when the control handle is in either gear position.

2. Move the control handle to **NEUTRAL** and turn the key switch to **START**. The engine should now crank.

3. If the engine does not respond as indicated, check the wiring in the key switch and remote control. Repair as needed.

Check Engine Operation

⚠ 1. Check fuel system for leaks and correct as necessary.

Note Use 50:1 mixture in the fuel until oil system function is verified.

⚠ 2. Shift the unit into **FORWARD** and **REVERSE** several times. If you encounter shifting problems, check that remote control adjustments are as specified by the manufacturer and check shift gate adjustments according to directions in **Install Shift Cable**.

3. Start the engine and check cooling system operation. Be sure the engine warms to operating temperature at idle.

⚠ 4. Check the electrical and ignition systems for stray spark sources.

5. Check all adjustments.

6. Check steering operation – the steering must turn an equal distance each way from centered position. Be sure the boat's bow moves in the direction the steering wheel is turned and that the cable moves smoothly.

7. Review Operator's Manual information, including owner's responsibilities and engine requirements.

8. Complete the paperwork:

- Registration **Ⓟ**
- Dealer's customer record **Ⓒ**
- Owner's identification card **Ⓓ**

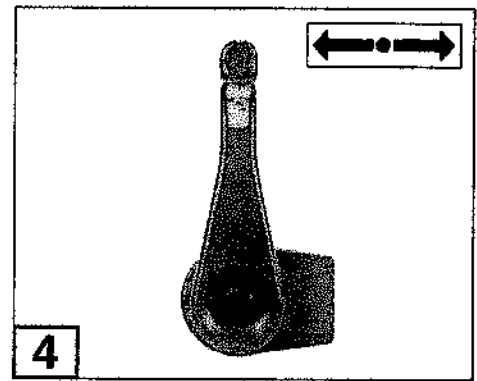

21153

Engine Registration	Model	Serial
Sold To		Owner's Phone
Name		
Address		
City	State	Zip
Purchase Date	Type of Use	
	<input type="checkbox"/> Pleasure <input type="checkbox"/> Commi <input type="checkbox"/> Govt	
Sold By		
Dealer Name		
Address		
City	State	Zip
Please Type or Print		Dealer Code
I acknowledge receiving the Owner's/Operator's manual for this product.		
Customer's Signature		

Ⓟ

Model	Serial Number
DEALER RECORD CARD	
Owner's Name	
Address	
City	State Zip
Second Owner Name	
Address	
City	State Zip
Date of Purchase	Ignition Key No
Boat Mfg	Hull No
Boat Model	Boat Length
<small>Important: The Federal Boat Safety Act requires registration lists to be maintained on product sales by manufacturer and DEALER. This is a standard card on which a dealer can keep his records.</small>	

Ⓒ

OMC OWNER IDENTIFICATION CARD	
Owner's Name	
Address	
City	State Zip
Date of Purchase	
MODEL#	SERIAL#

Ⓓ

